

Tomáš Palou | 2018

foodprint

instant garden



PROBLEMATIKA

bylinky z obchodu — *určené k priamej spotrebe*
nevydržia dlho
slabá koreňová vetva
pestované pod umelým svetlom

pracnosť s výsadbou — *dostupnosť*
znečistenie
čas

rastlina — *podmienky*
priestor
zalievanie

Témy k premysleniu:

- **výroba**
pestovanie/zber/skladovanie
spracovanie

rýchla doba — rýchla spotreba

RIEŠENIE

Designový kvetináč — kvalitný materiál

3D PRINT — BIODEGRADOVATEĽNÝ MATERIÁL

KÚPIŤ • ROZBALIŤ • ZAVESIŤ • ZALIAŤ • ČAKAŤ • ZBIERAŤ

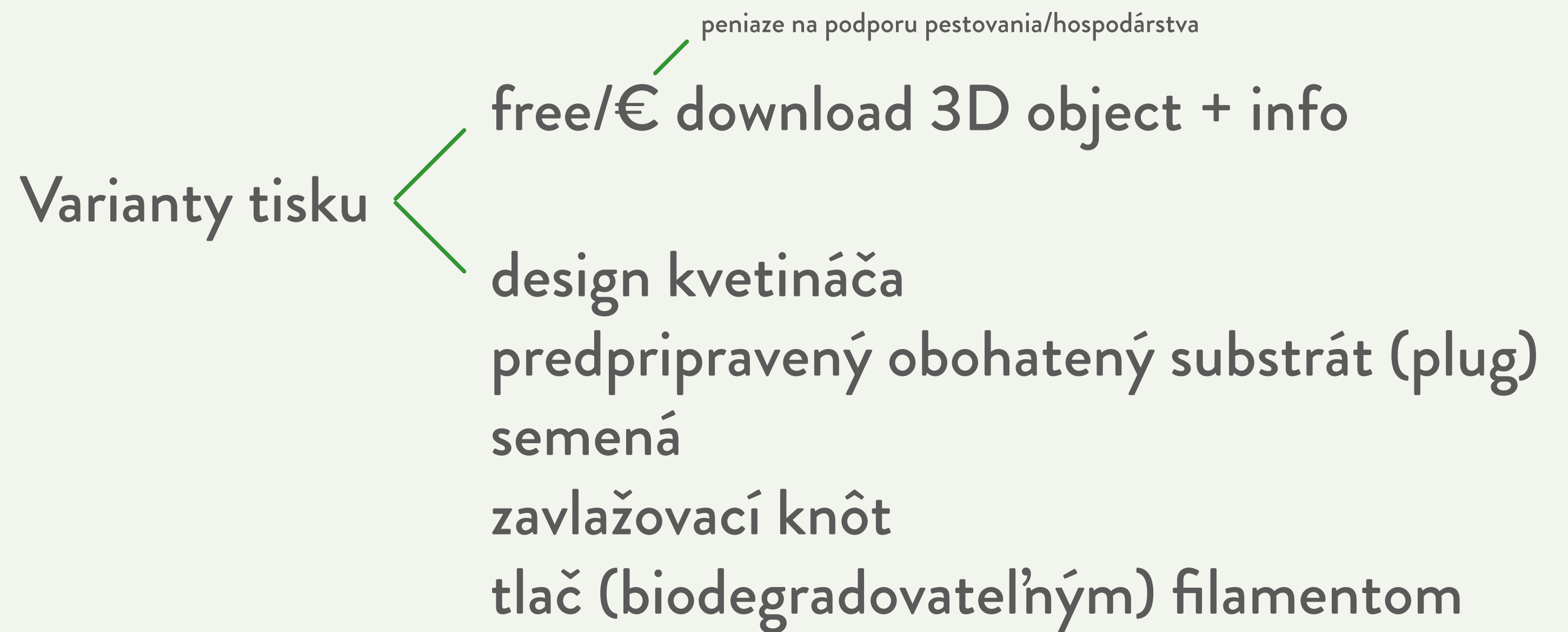

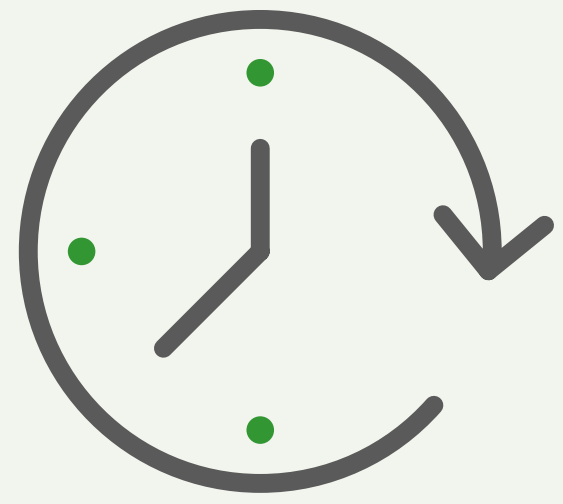

čas



H₂O

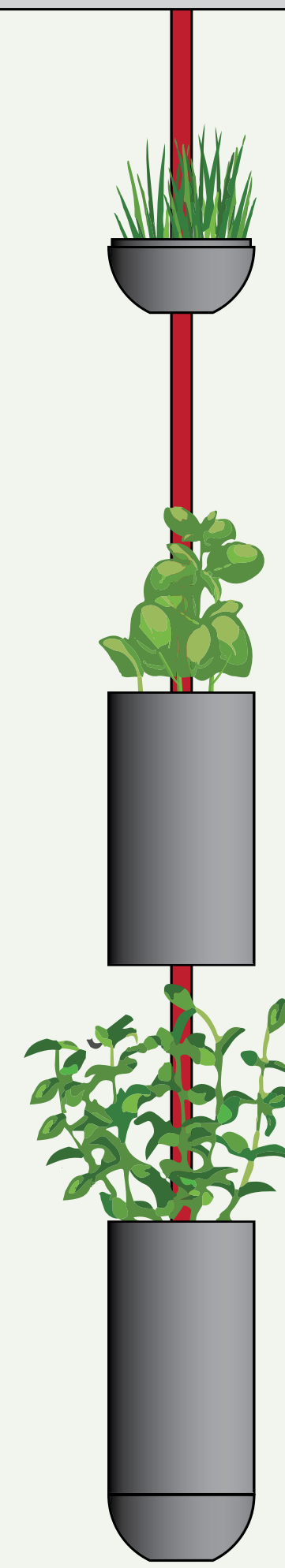
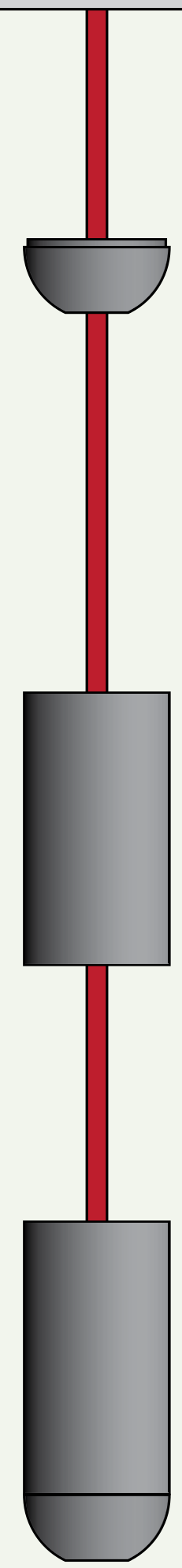
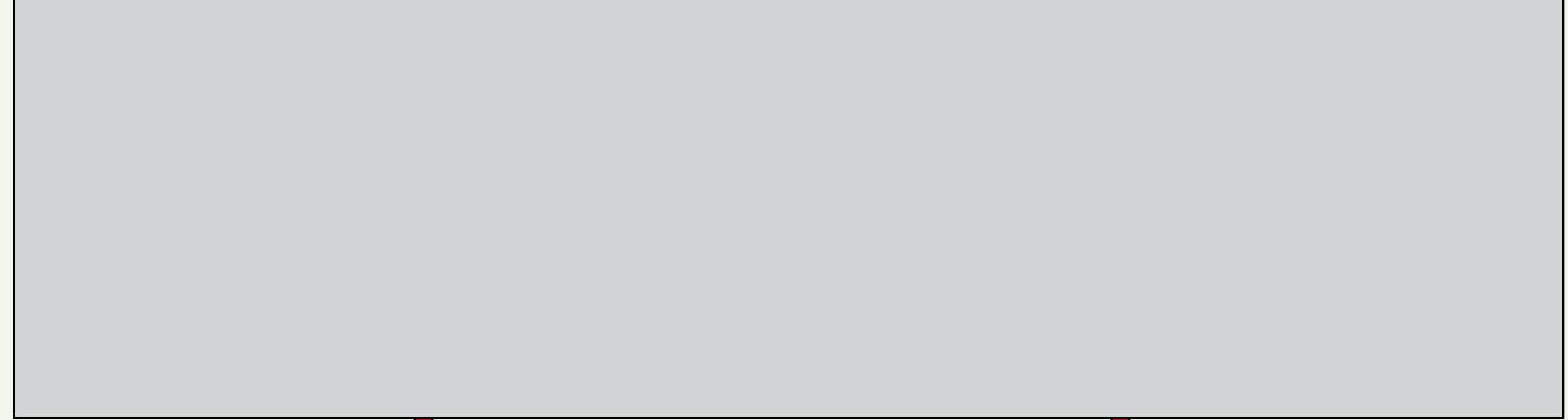
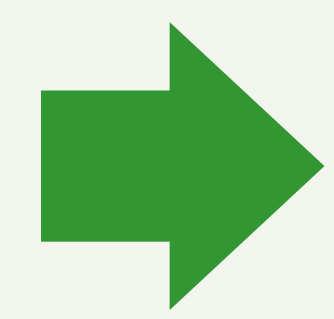
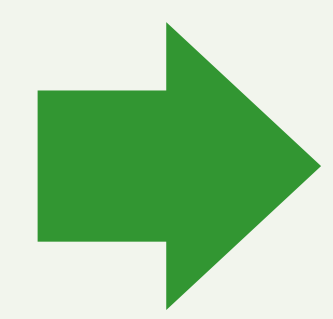

OBSAH BALENIA

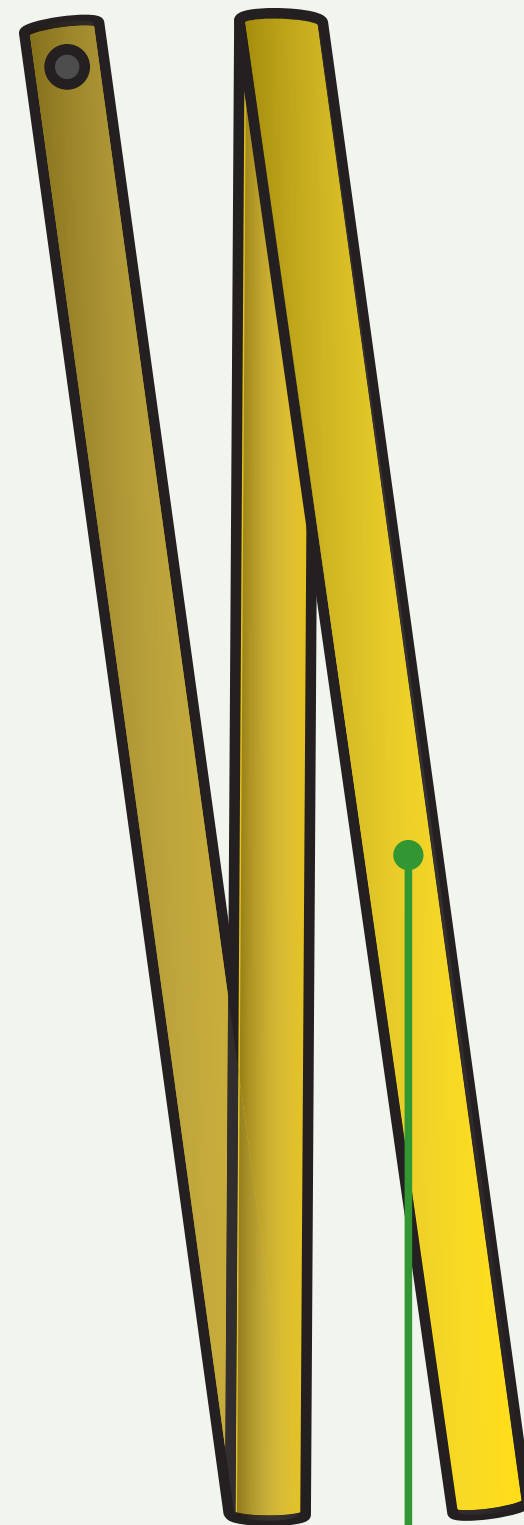
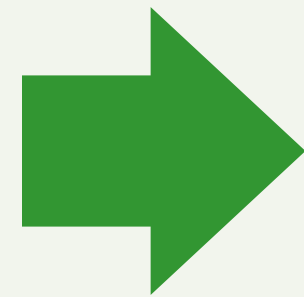
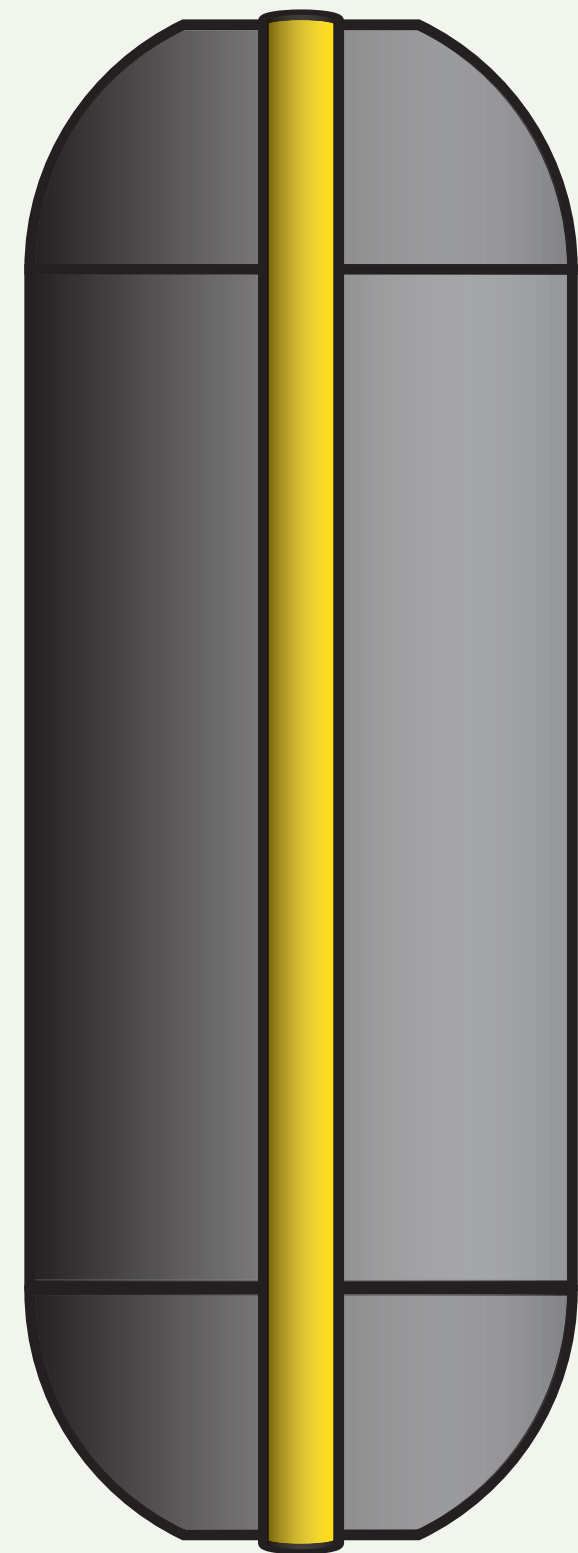

zavlažovací knôt

mini kvetináč

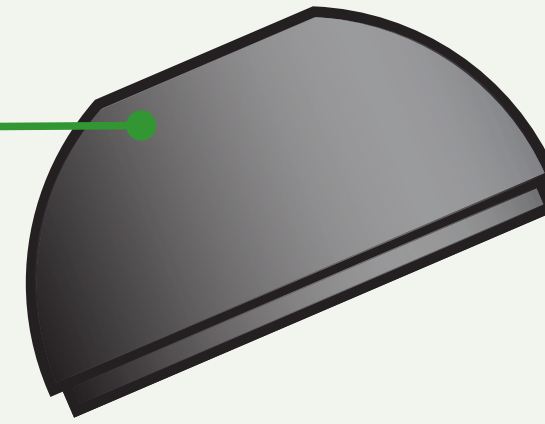

kvetináč

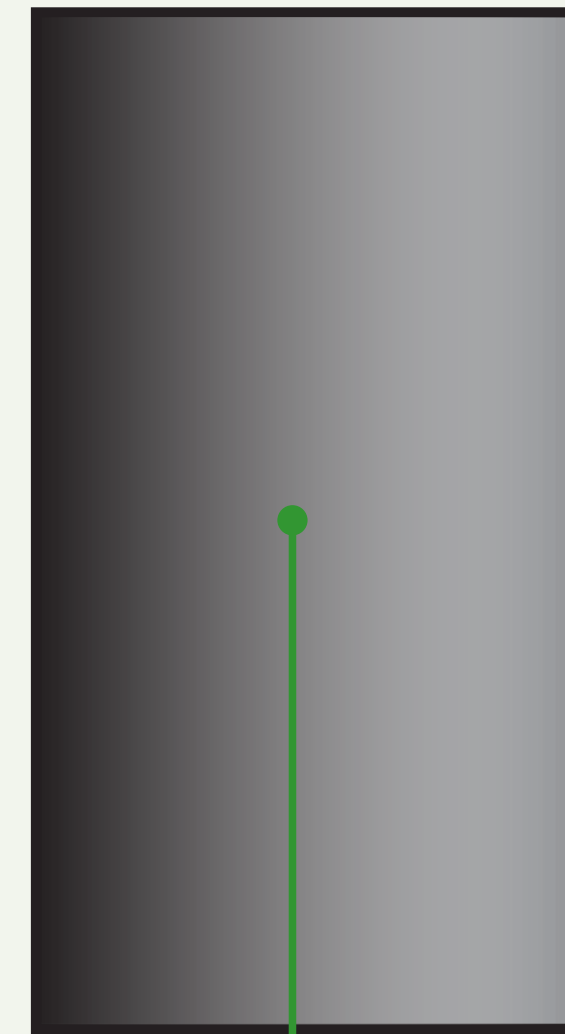

rezervoár

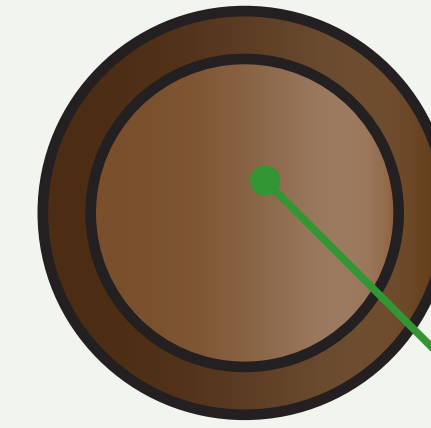
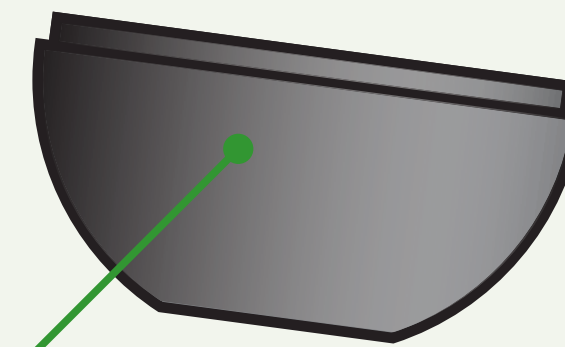

rašelinové tablety

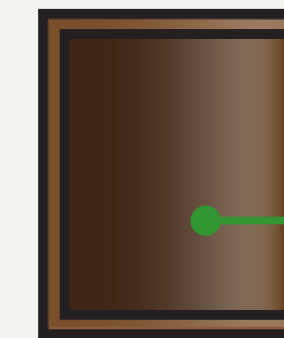
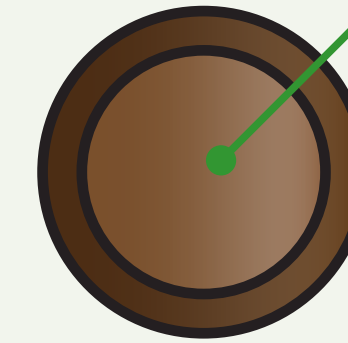

semená



- samozvážovací systém (rezervoár vo vrchnom kvetináči)
- jednoduchá údržba/výmena
- zalievanie gravitáciou — knôt/hadička

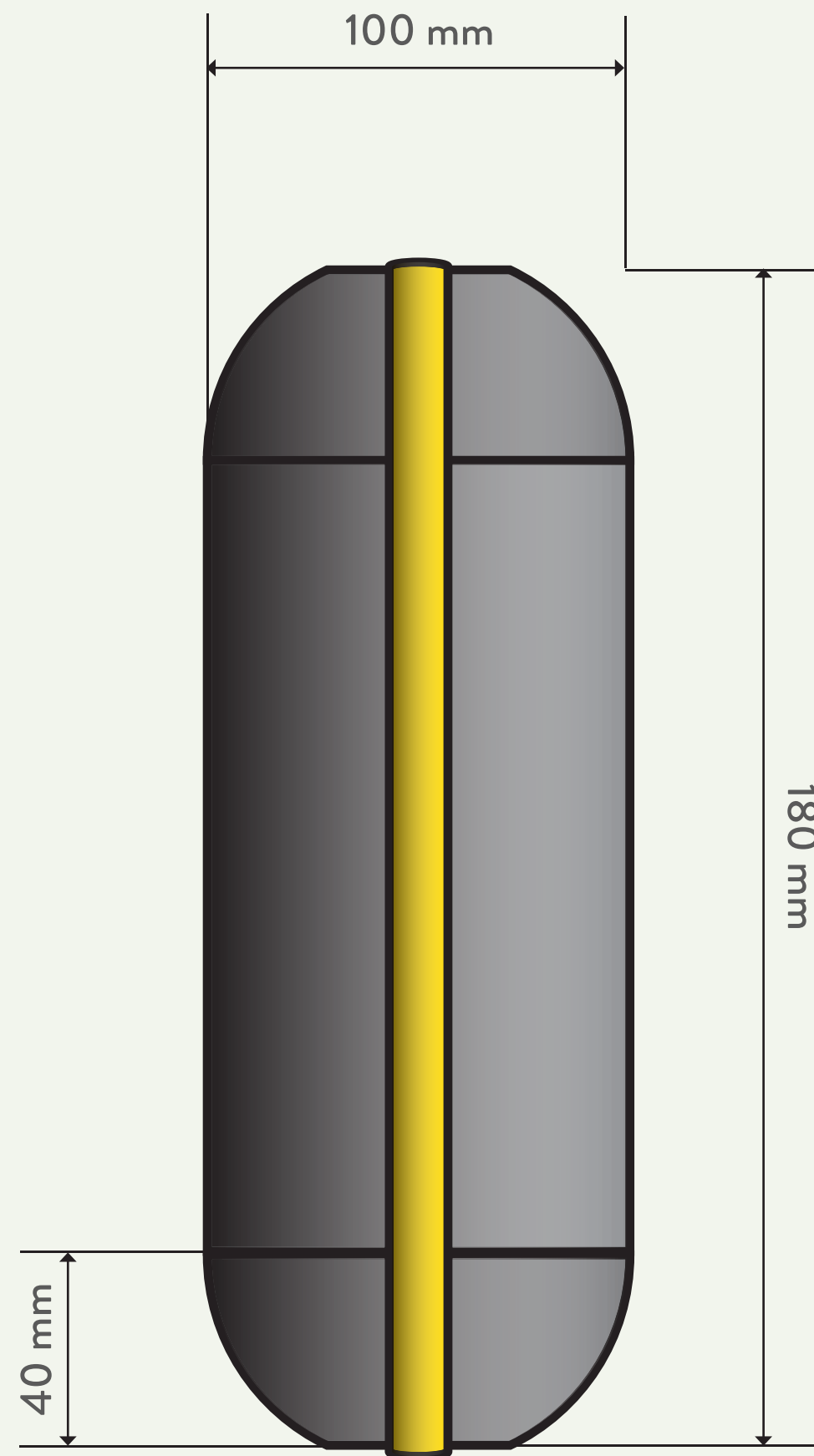

Zrezanie — možnosť stabilného vertikálneho postavenia
Zárez v spodnej podstave umožňuje prepásanie knôtom (vertikálne)



Zavesenie — očko s vrutom/karabina

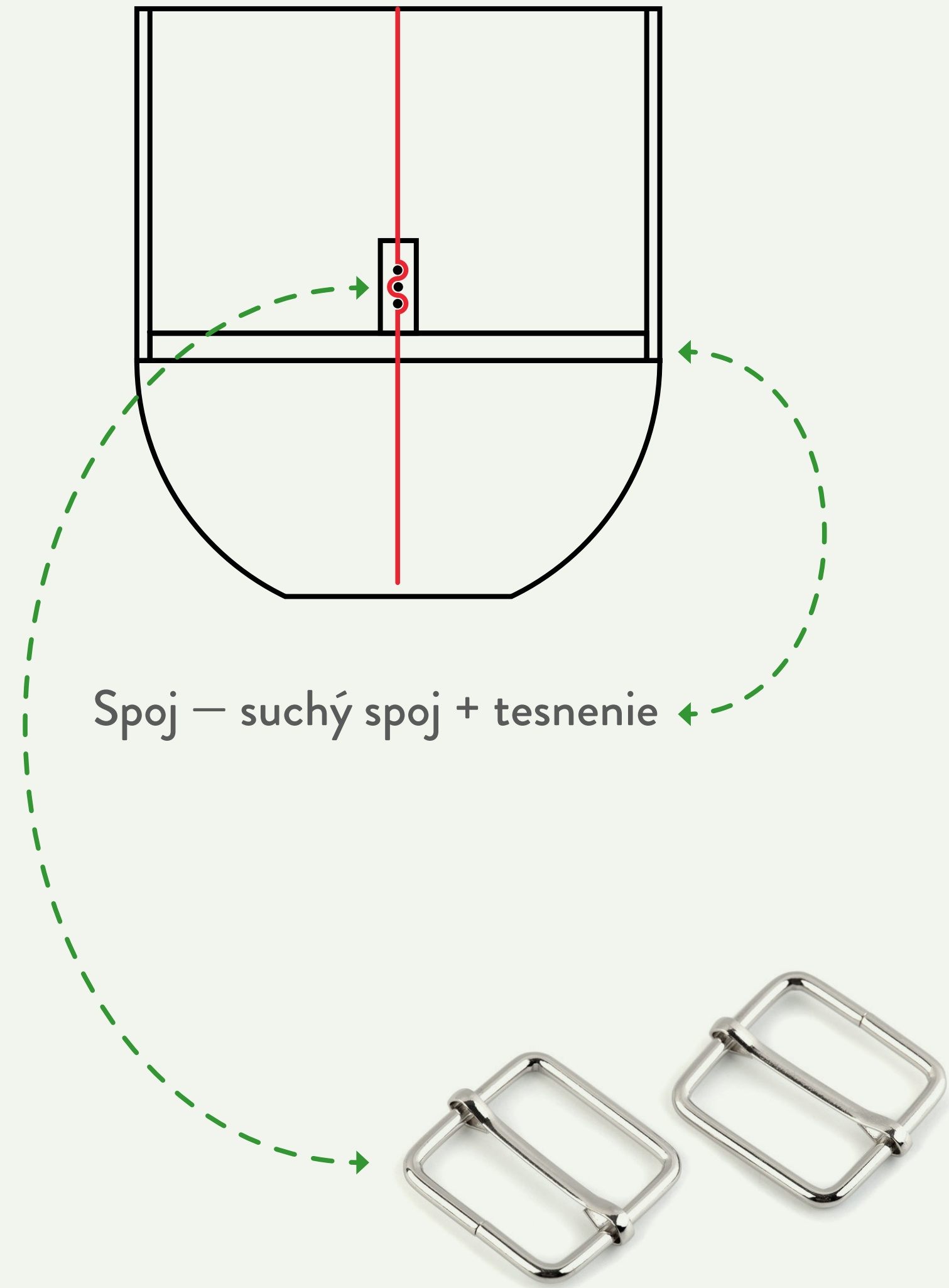

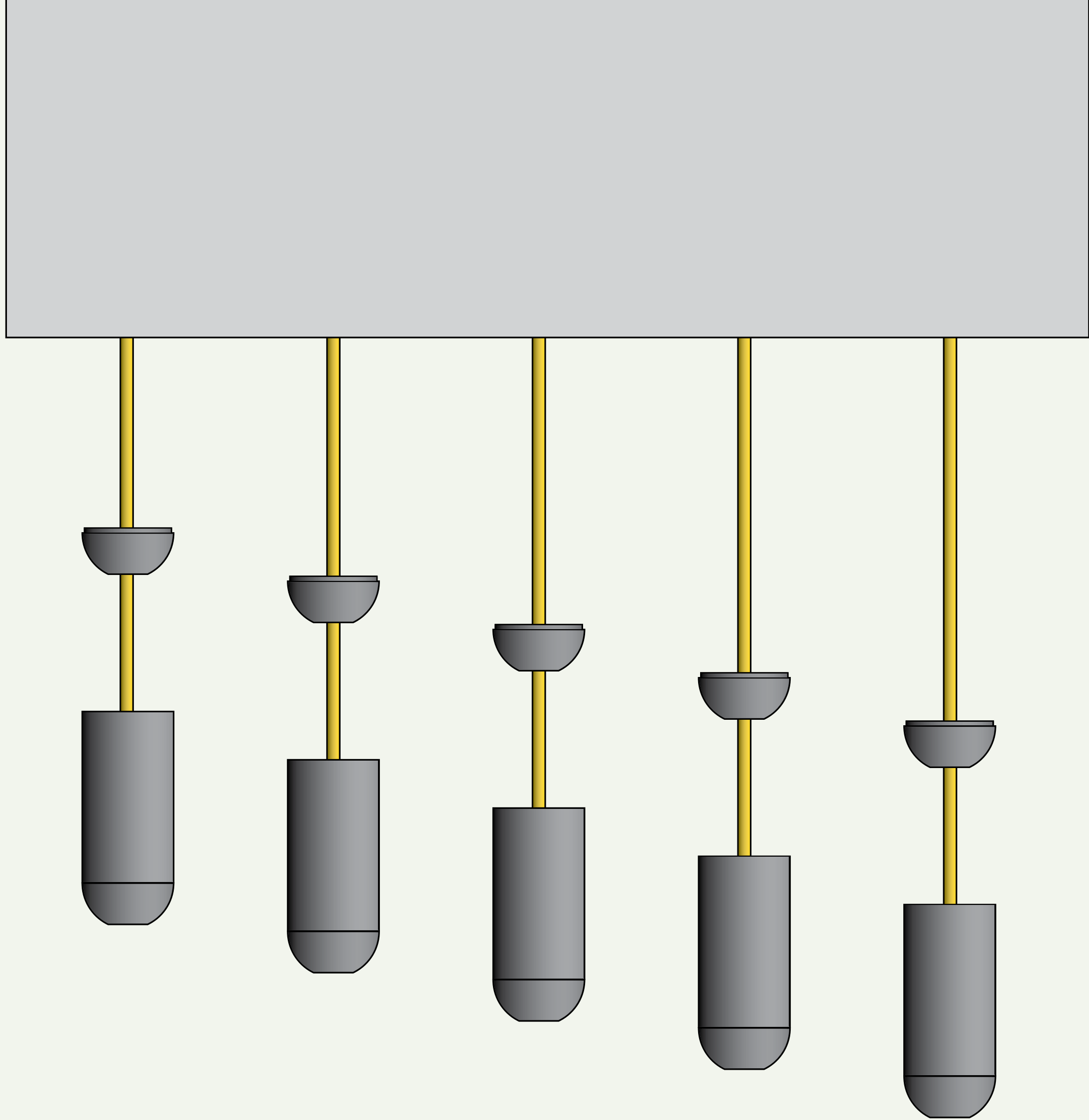

a.

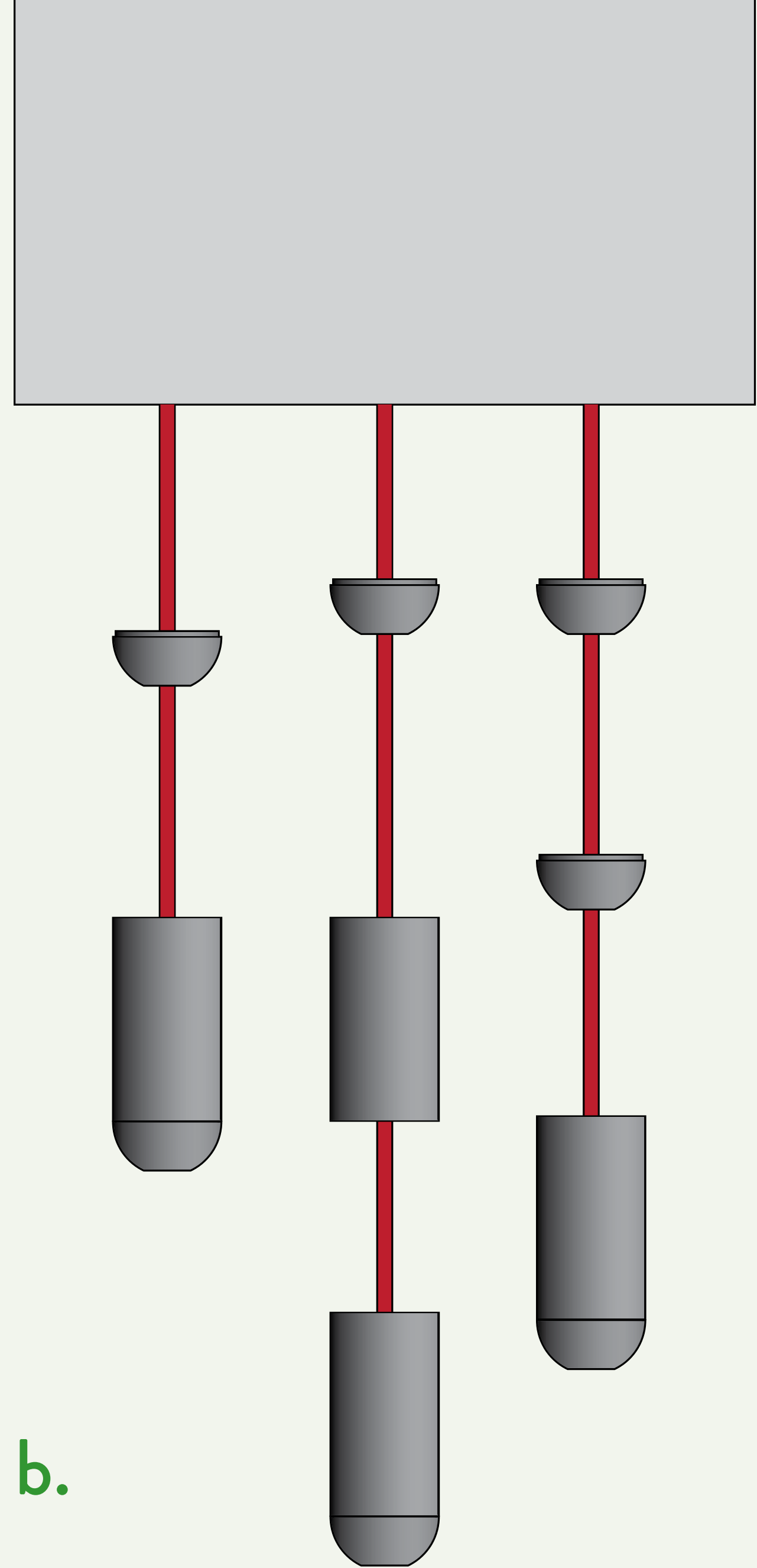

b.

ĎAKUJEM ZA POZORNOST