

**R G B**  
**L I G H T**

- Zadaním bolo vytvoriť **svietidlo** zo zadaného materiálu - **plexisklo**.
- Dominantný **materiál** musí byť plexisklo
- Jednoduchý a súčasný dizajn
- Variabilné **využitie**
- Vyriešiť **zdroj svetla a napájanie**
- Možnosť použiť **prídavný materiál** alebo funkciu.

**ZADANIE**





**RIEŠENIE**

# VARIABILITA

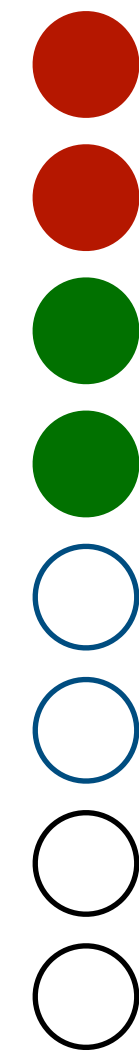
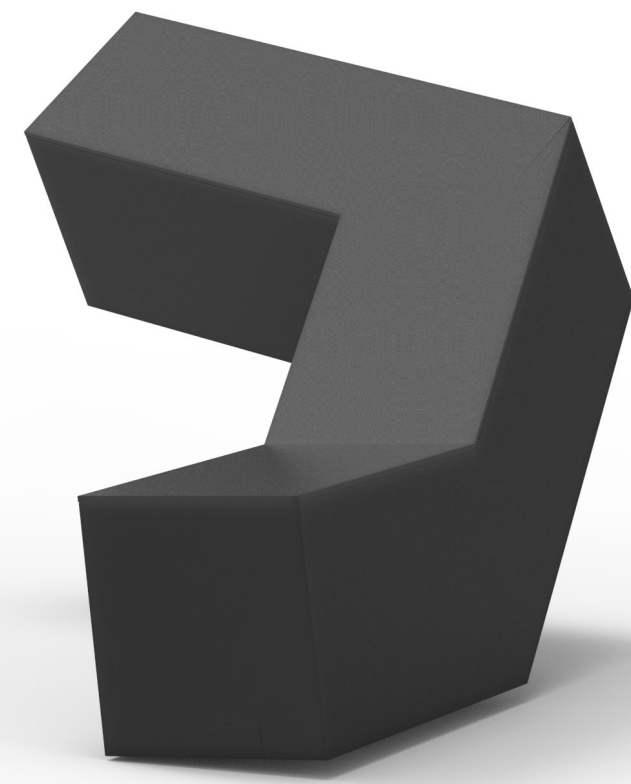
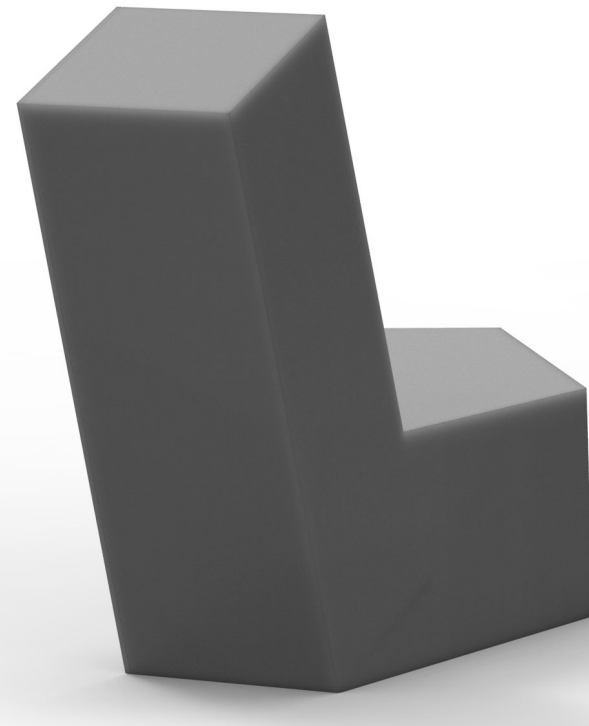
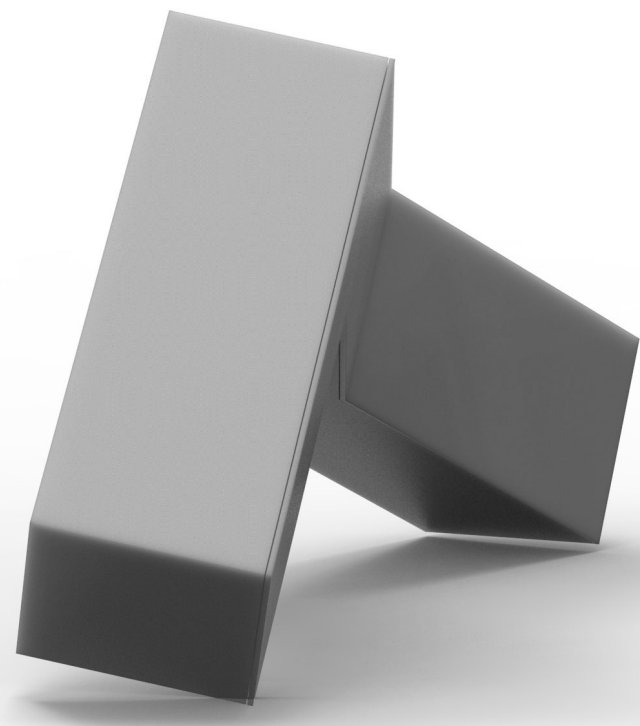
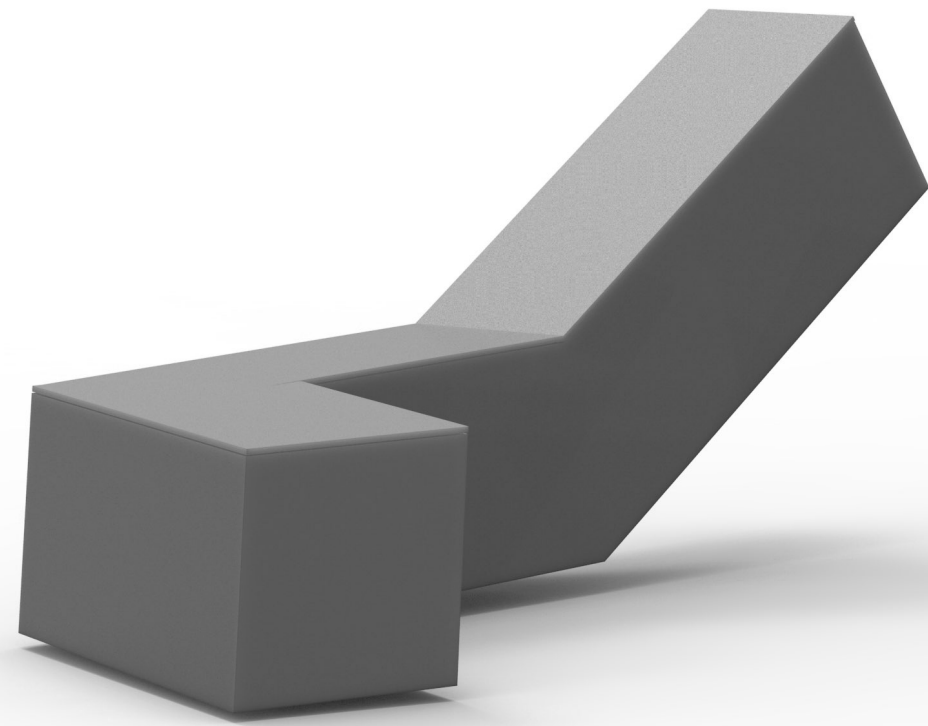

RED

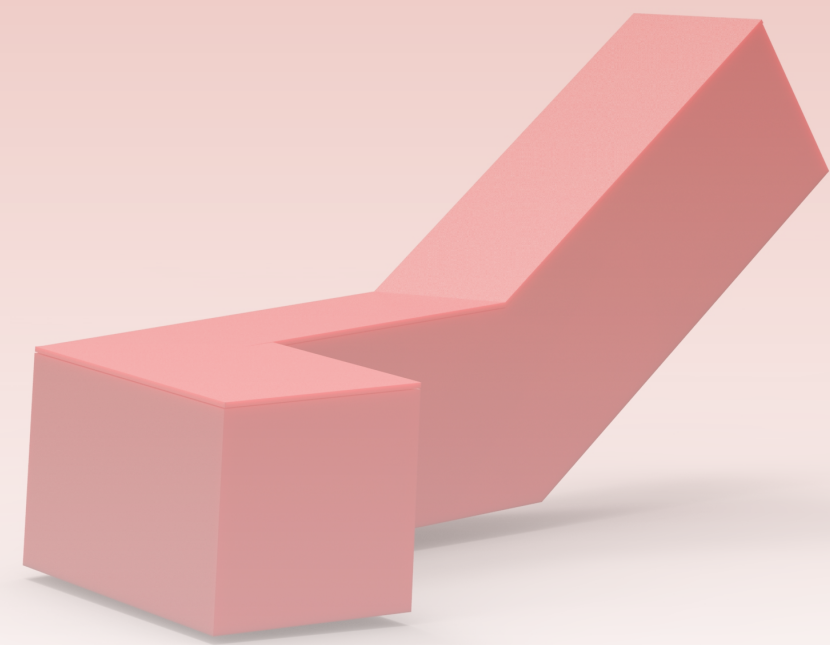

GREEN

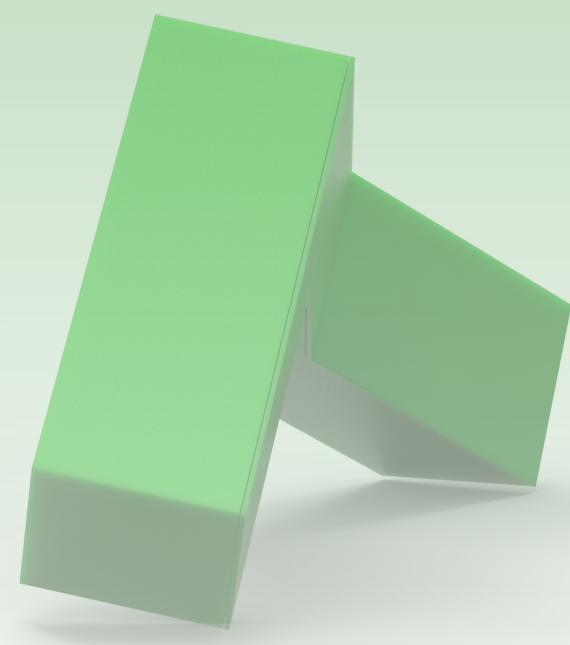

BLUE

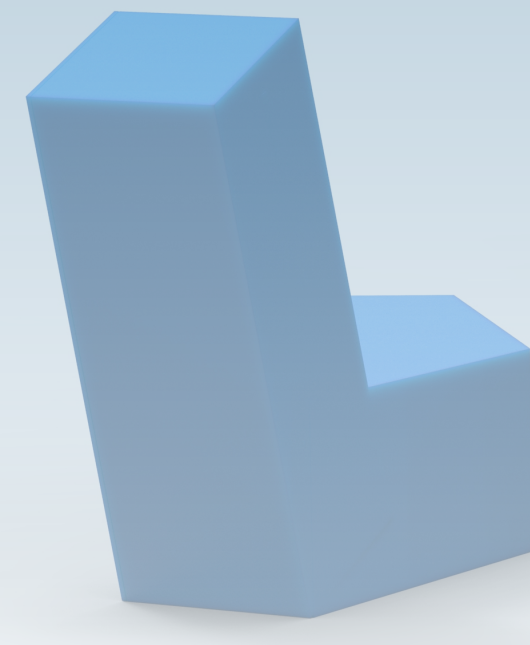

WHITE

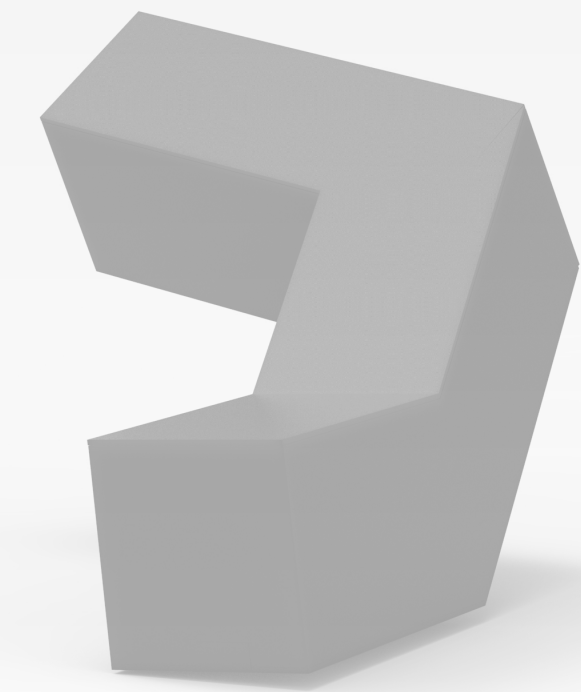

RGB

- 1 Led pásik (5V)
- 2 RGB trafo
- 3 USB kábel

**ZDROJ**

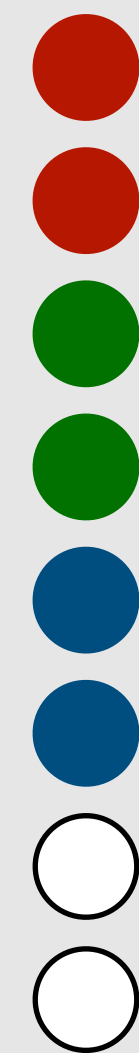
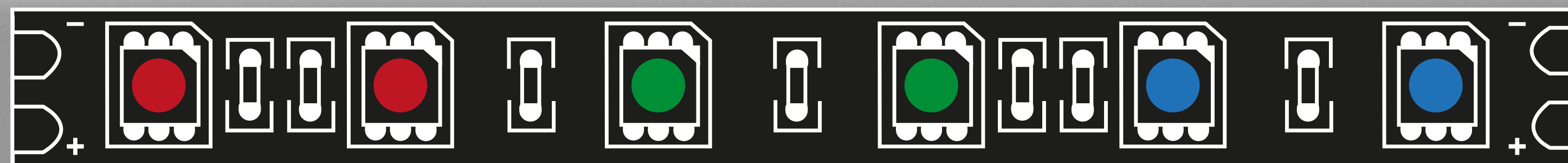

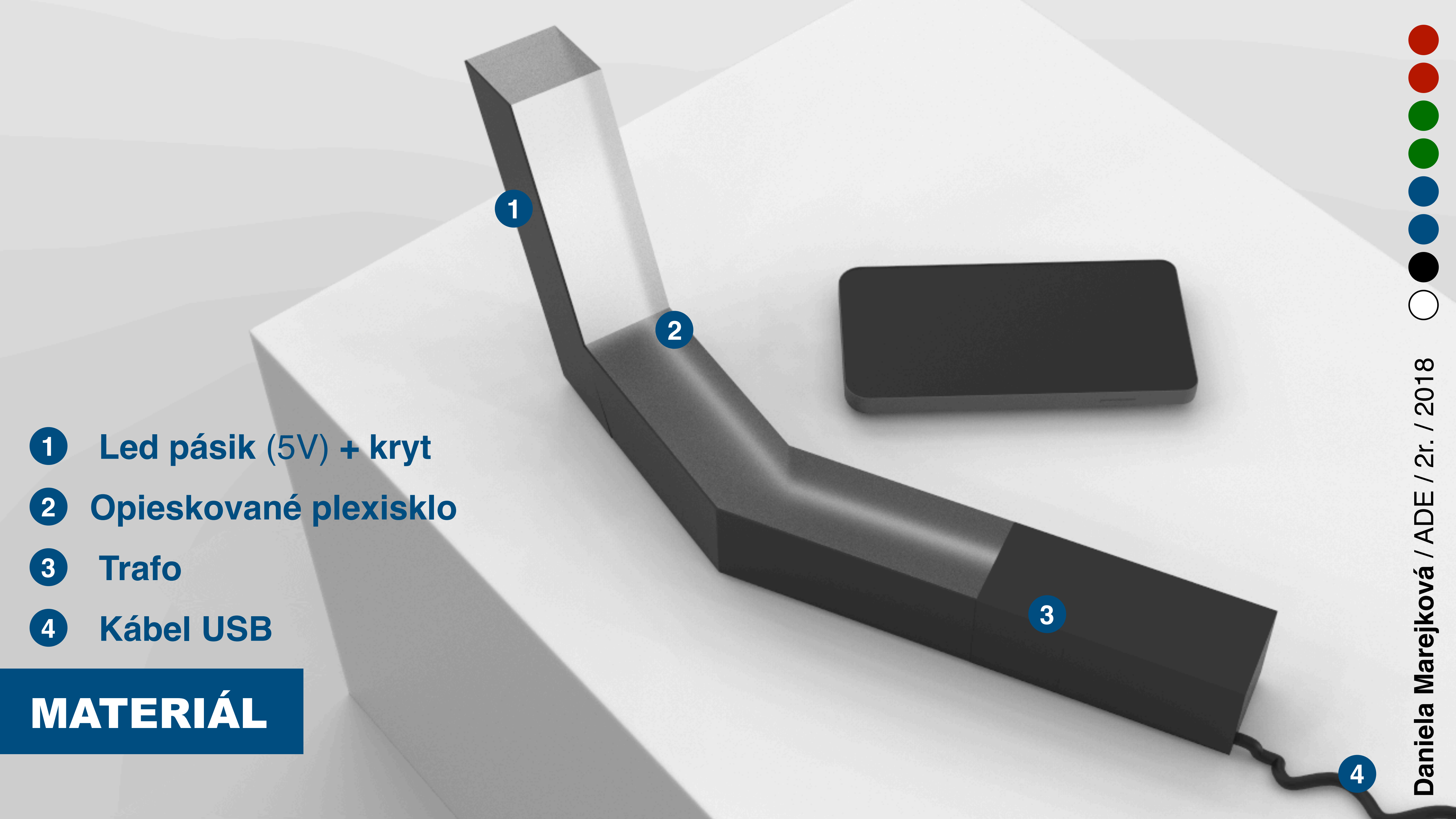
- 
- 1 Led pásik (5V) + kryt
  - 2 Opieskované plexisklo
  - 3 Trafo
  - 4 Kábel USB

## MATERIÁL



# ROZMERY

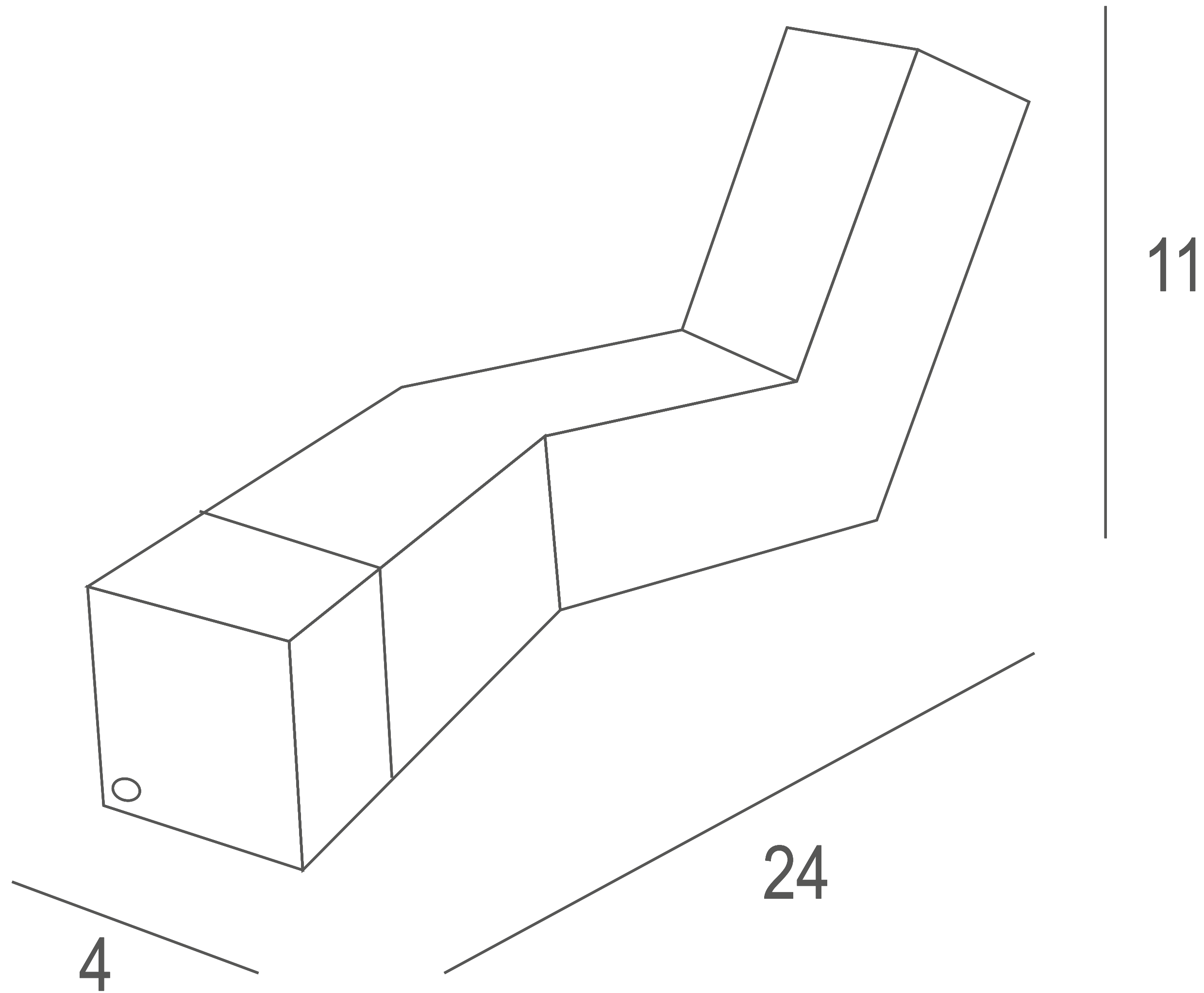



**2018**

