

Sada na pracovný stôl



ZADANIE

00 — Navrhnuť sadu minimálne troch doplnkov na pracovný stôl tak, aby sa dala poskladať z plošných dielov

Oliver Drengubiak / UTB / FMK / ADE1

1



KONCEPT

01 — Základ návrhu je založený na tom, že sa všetky kusy setu dajú vložiť do stojana v ktorom voľne visia na postranných výstupkoch. Pod samotným stojanom tak vzniká voľný ukladací priestor.

2



FINÁLNÝ NÁVRH

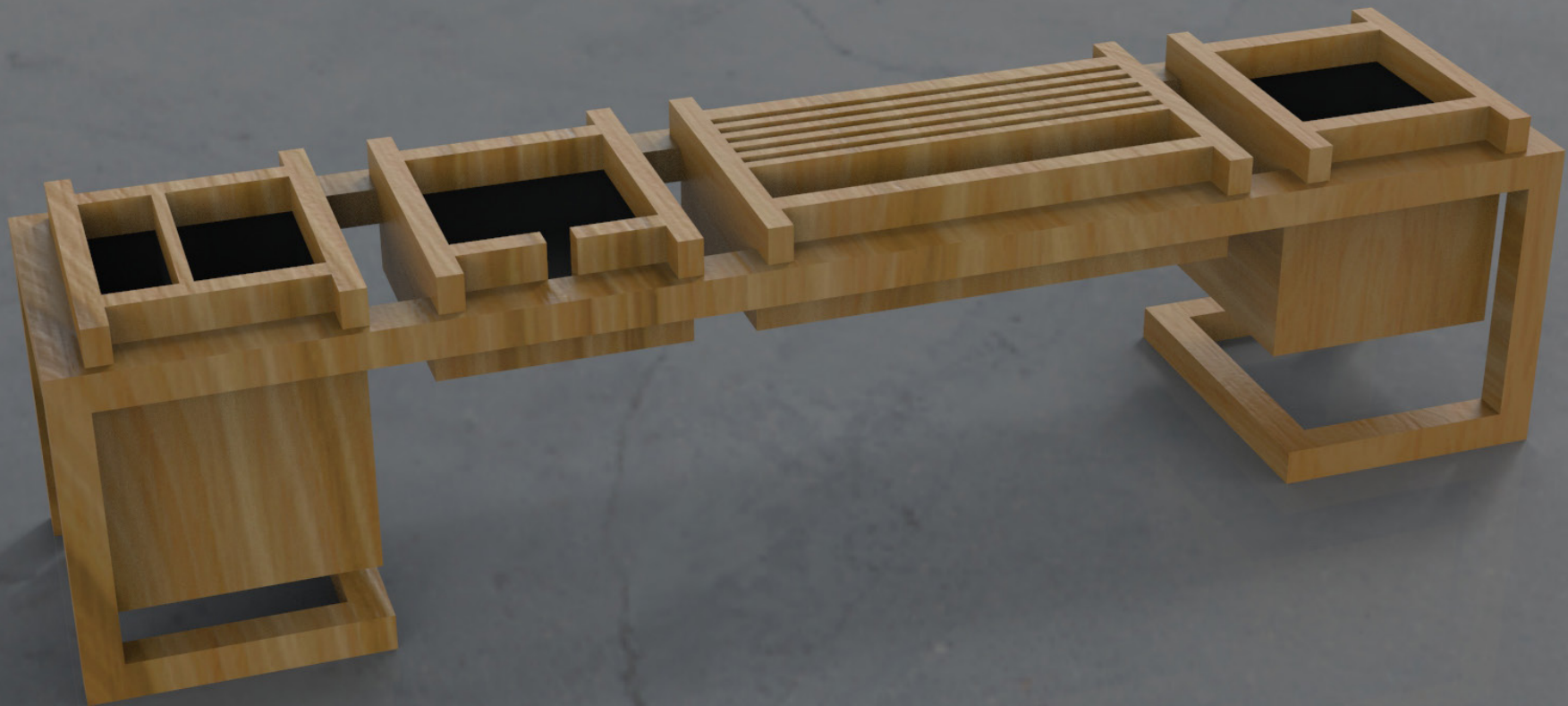

MATERIÁL

02 — Celá sada je postavená z 9mm preglejky, lepená lepidlom na drevo. Vnútorne steny sú natreté čiernou latexovou farbou, ktorá zaručuje vodotesnosť v prípade kvetináča. Pri ostatných komponentoch slúži ako ochranná vrstva.



ROZMERY

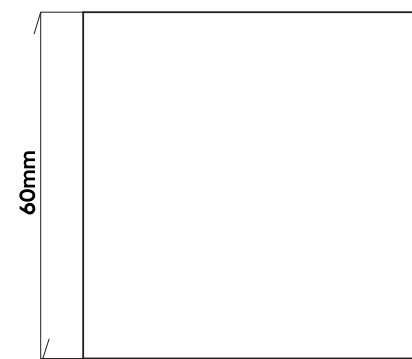
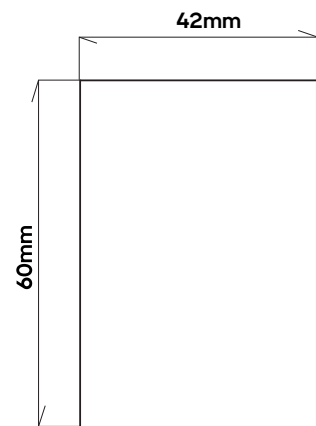
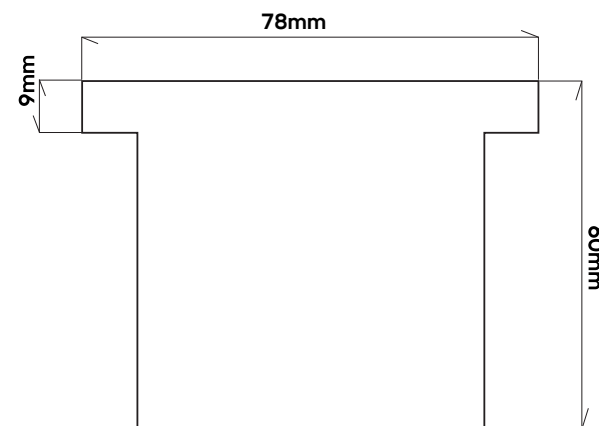
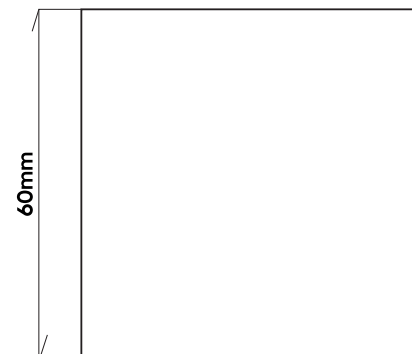
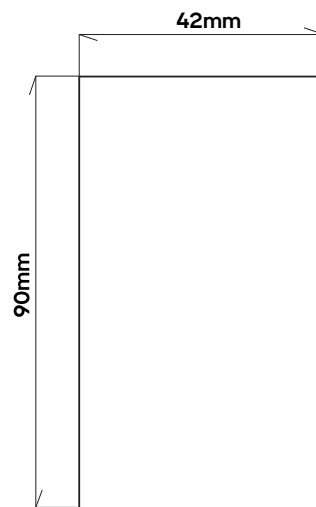
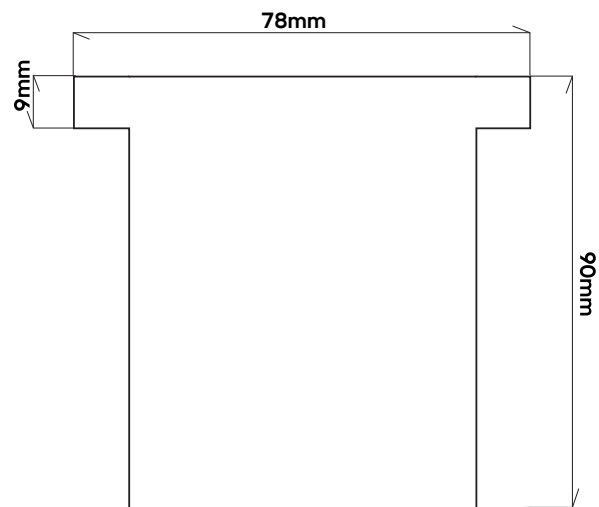

ROZMERY

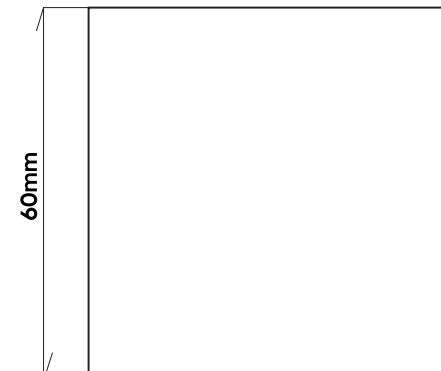
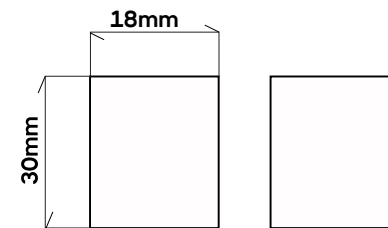
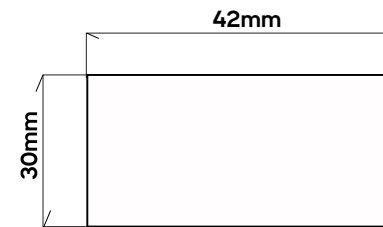
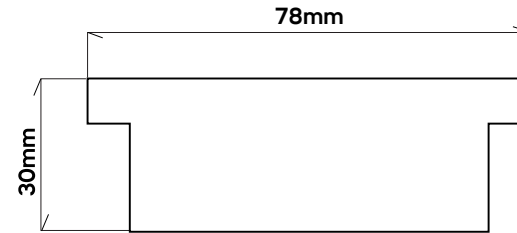
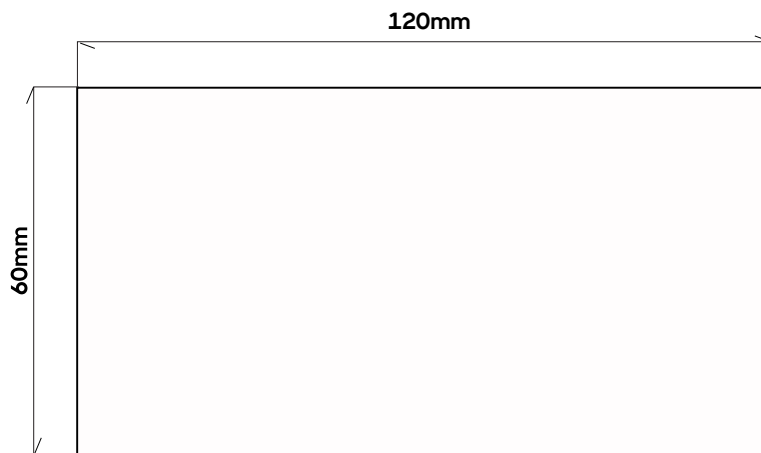
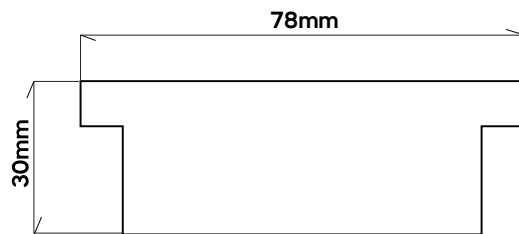
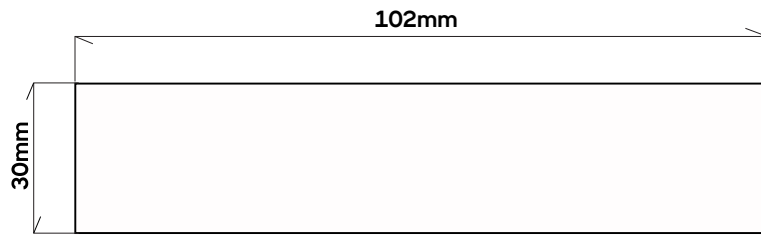



7

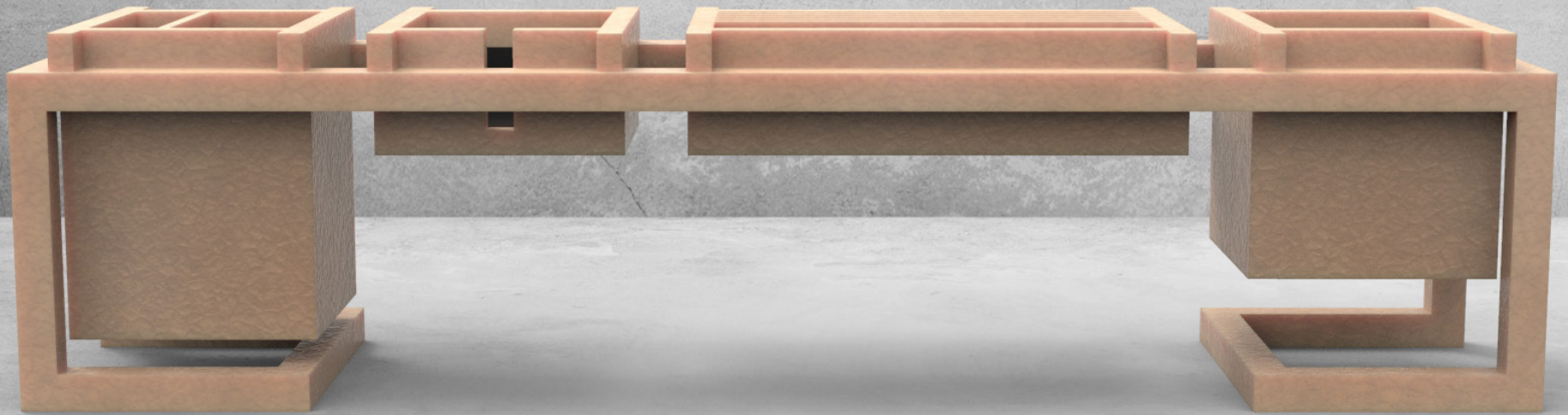

8

